



MAX3693 Evaluation Kit

General Description

The MAX3693 evaluation kit (EV kit) is an assembled, surface-mount demonstration board that provides easy evaluation of the MAX3693 622Mbps serializer with clock synthesis and LVDS inputs.

Component List

DESIGNATION	QTY	DESCRIPTION
C4–C9, C11, C12, C16–C21	14	0.1 μ F, 10%, 25V min ceramic capacitors
C13, C22	2	1 μ F, 10%, 10V min ceramic capacitors X7R type
C14	1	1 μ F, 10%, 25V min ceramic capacitor
C15	1	33 μ F, \pm 10%, 10V min tantalum capacitor AVX TAJD336K010
L1–L5	1	56nH inductors Coilcraft 0805CS-560XKBC
R1, R2, R11, C1–C3, C10, JU1, JU2, JU4, JU11–JU15	0	Not installed
R3, R4	2	27 Ω , 5% resistors
R5, R6	2	220 Ω , 5% resistors
R7, R8	2	130 Ω , 5% resistors
R9, R10	2	24 Ω , 5% resistors
R12	1	20k Ω , 5% resistor
PCLKI+, PCLKI-, PD0+, PD0-, PD1+, PD1-, PD2+, PD2-, PD3+, PD3-, PCLK0+, PCLK0-	12	SMB connectors (PC-mount)
RCLK+, RCLK-, SD+, SD-	4	SMA connectors (PC-mount)
GND, +3.3V	2	Test points
JU3	1	2x3 pin header
U1	1	MAX3693ECJ (32 TQFP)
	1	MAX3693 PC board
	1	MAX3693 data sheet
	1	Shunt for JU3

Component Suppliers

SUPPLIER	PHONE	FAX
AVX	803-946-0690	803-626-3123
Coilcraft	847-639-6400	847-639-1469

Features

- ◆ **Single +3.3V Supply**
- ◆ **Selectable Clock-Reference Frequencies (155.52MHz, 77.76MHz, 51.84MHz, 38.88MHz)**
- ◆ **Fully Assembled and Tested Surface-Mount Board**

Ordering Information

PART	TEMP. RANGE	IC PACKAGE
MAX3693EVKIT	-40°C to +85°C	32 TQFP

Detailed Description

The MAX3693 EV kit simplifies evaluation of the MAX3693. The EV kit operates from a single +3.3V supply and includes all the external components necessary to interface with LVDS inputs and 3.3V PECL outputs.

The LVDS inputs (PD₊, PD₋, PCLKI₊, PCLKI₋, RCLK₊, RCLK₋) are internally terminated with 100 Ω differential input resistance, and therefore do not require external termination. Ensure that LVDS devices driving these inputs are not redundantly terminated. The LVDS outputs (PCLKO₊, PCLKO₋) require a differential termination with a 100 Ω resistor between complementary outputs.

The evaluation kit is designed to directly couple an LVDS reference clock. If the reference clock does not have LVDS-compatible levels:

- 1) Cut the PC board traces shorting capacitors C1 and C2.
- 2) Install 0.1 μ F capacitors.
- 3) Install 4.99k Ω resistors for R1 and R2 and tie the centerpoint of R1 and R2 (available at JU1) to V_{CC} / 2. Install a 0.1 μ F capacitor at C3 for additional noise filtering.

The PECL outputs have an attenuation (0.6) and impedance matching network on the EV board that allow 50 Ω terminations to ground for oscilloscope interfacing. All signal inputs and outputs use coupled 50 Ω transmission lines. All input signal lines are of equal length to minimize propagation-delay skew. Likewise, all output signal lines are of equal length.

The MAX3693 EV kit allows use of multiple reference clock frequencies with the appropriate setting on JU3. See Table 1 for jumper settings.

Evaluates: MAX3693



MAX3693 Evaluation Kit

Evaluates: MAX3693

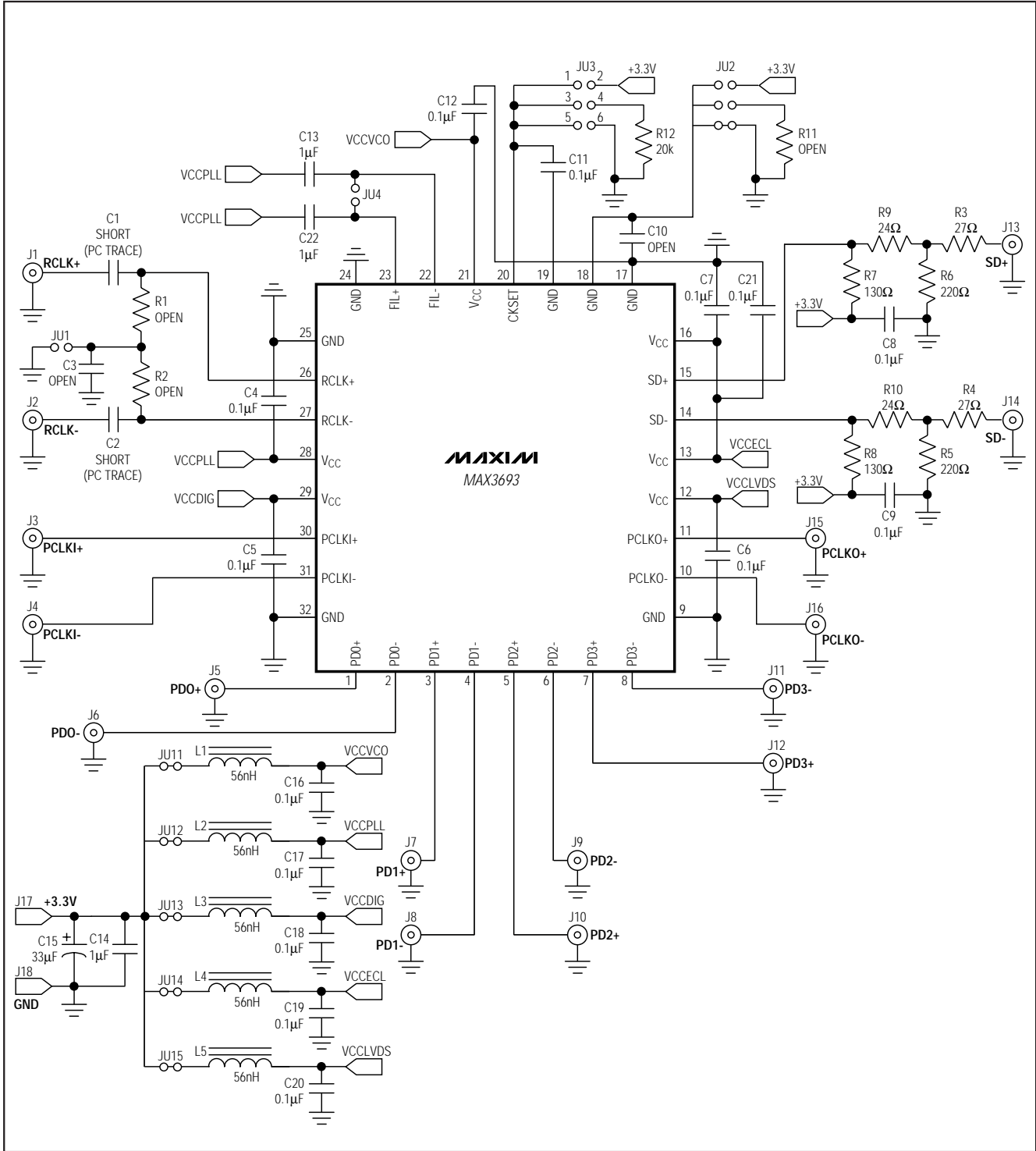

Figure 1. MAX3693 EV Kit Schematic

MAX3693 Evaluation Kit

Evaluates: MAX3693

Table 1. Jumper JU3 Functions

SHUNT LOCATION	REFERENCE CLOCK FREQUENCY (MHz)	CKSET PIN
1-2	155.52	Connected to Vcc
3-4	51.84	Connected through 20kΩ resistor to GND
5-6	38.88	Connected to GND
Open	77.76	Floating

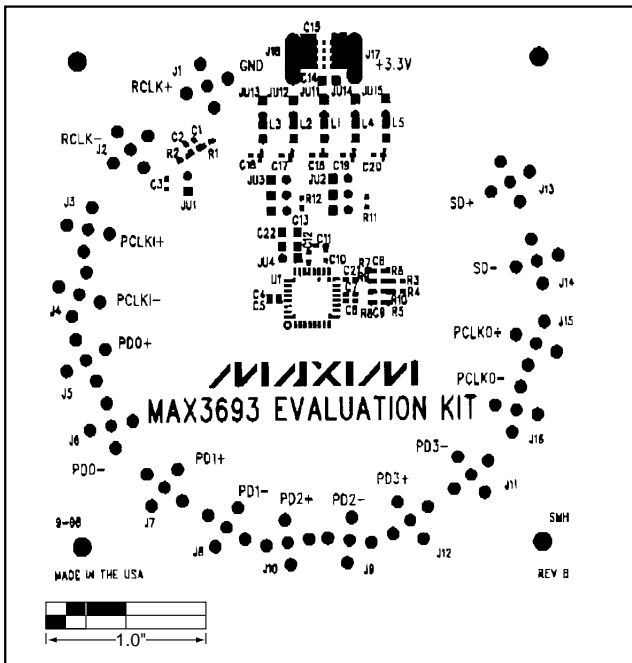
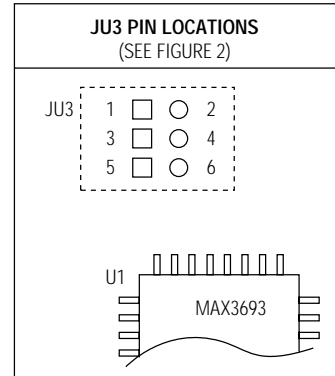

Figure 2. MAX3693 EV Kit Component Placement Guide—Component Side

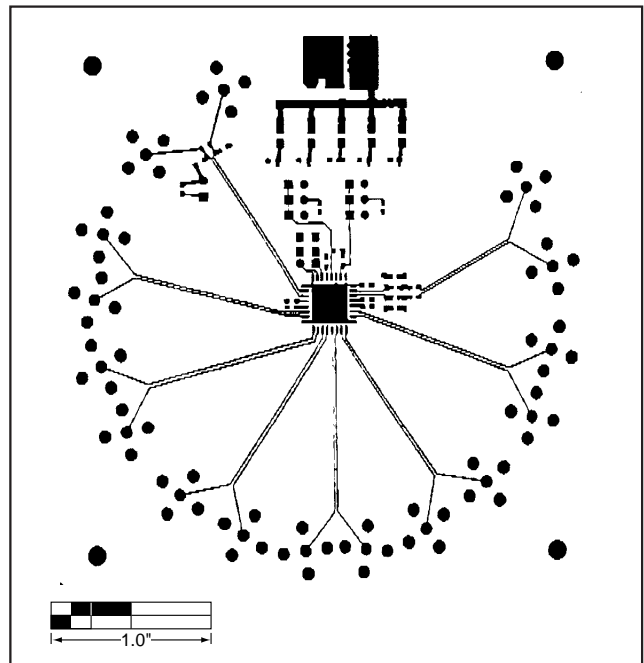

Figure 3. MAX3693 EV Kit PC Board Layout—Component Side

MAX3693 Evaluation Kit

Evaluates: MAX3693

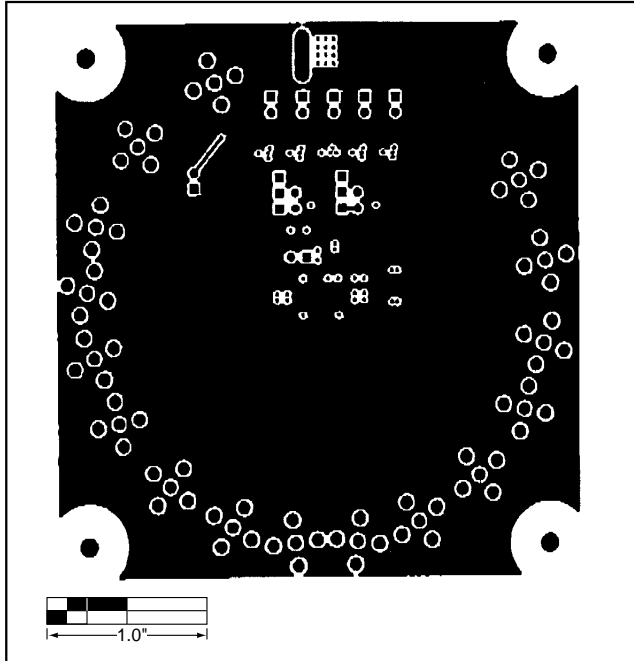

Figure 4. MAX3693 EV Kit PC Board Layout—Solder Side

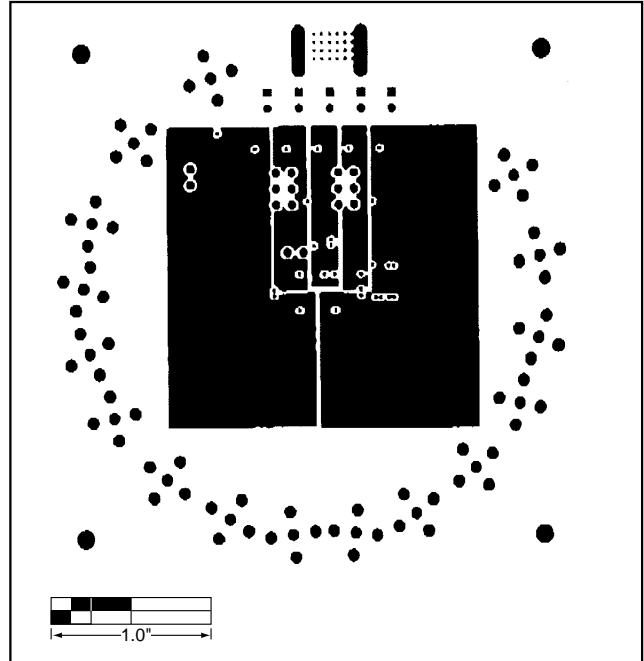

Figure 5. MAX3693 EV Kit PC Board Layout—Power Plane

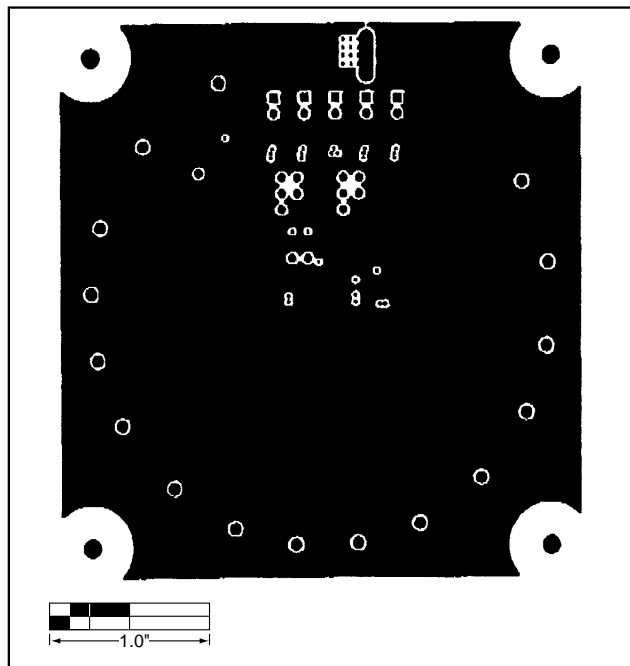

Figure 6. MAX3693 EV Kit PC Board Layout—GND Plane

Maxim cannot assume responsibility for use of any circuitry other than circuitry entirely embodied in a Maxim product. No circuit patent licenses are implied. Maxim reserves the right to change the circuitry and specifications without notice at any time.

4 _____ Maxim Integrated Products, 120 San Gabriel Drive, Sunnyvale, CA 94086 408-737-7600